

# **Novergy User Manual Inverter IGPB-V-3KW**



## Table of Contents

---

1	Notes on this manual.....	4
1.1	Validity .....	4
1.2	Target group .....	4
1.3	Symbols used in this manual.....	5
2	Safety.....	6
2.1	Intended use .....	6
2.2	Safety standards.....	6
2.3	Important safety information.....	7
2.4	Symbols on the type label .....	10
2.5	Basic safety protection.....	11
3	Unpacking.....	12
3.1	Scope of delivery .....	12
3.2	Checking for transport damage.....	12
4	Mounting.....	13
4.1	Ambient conditions .....	13
4.2	Selecting the mounting location .....	15
4.3	Mounting the inverter with the wall bracket.....	16
5	Electrical connection.....	18
5.1	Safety .....	18
5.2	System layout of units without integrated DC switch.....	19
5.3	Overview of the connection area.....	20
5.4	AC connection.....	21
5.4.1	Conditions for the AC connection.....	21

5.4.2	Grid connection .....	22
5.4.3	Second protective grounding connection .....	25
5.4.4	Residual current protection.....	26
5.4.5	Overvoltage category .....	27
5.4.6	Rating of AC circuit breaker .....	27
5.5	DC connection.....	28
5.5.1	Requirements for the DC connection .....	28
5.5.2	Assembling the DC connectors .....	29
5.5.3	Disassembling the DC connectors .....	31
5.5.4	Connecting the PV array .....	32
6	Communication .....	33
6.1	System monitoring via R485 .....	33
7	Commissioning.....	40
7.1	Electrical checks .....	40
7.2	Mechanical checks.....	41
7.3	Start-up .....	42
8	Disconnecting the inverter from voltage sources.....	43
9	Operation .....	45
9.1	Overview of the control panel.....	45
9.1.1	Display.....	46
9.1.2	Control button .....	47
9.1.3	LEDs .....	47
9.2	Display messages .....	48
9.3	Language and safety regulation settings.....	50



9.3.1 Language setting .....	50
9.3.2 Safety regulation setting .....	50
10 Technical Data .....	52
10.1 DC input data.....	52
10.2 AC output data.....	53
10.3 General data.....	54
10.4 Safety regulations .....	55
10.5 Power reduction .....	61
10.6 Tools and torque.....	63
11 Troubleshooting .....	64
12 Maintenance .....	66
12.1 Cleaning the contacts of the DC switch .....	66
12.2 Cleaning the heat sink .....	66
13 Recycling and disposal .....	67
14 Warranty .....	67
15 Contact .....	68

# 1 Notes on this manual

---

## General Notes

IGPB is a transformerless solar inverter with a single MPP tracker.

It converts the direct current (DC) from PV arrays to grid-compliant alternating current (AC) and feeds it into the utility grid.

### 1.1 Validity

---

This manual describes the mounting, installation, commissioning and maintenance of the following Novergysolar inverters: IGPB 1000, IGPB 1500, IGPB 2000, IGPB 3000.

Observe all documentation that accompanies the inverter. Keep them in a convenient place and available at all times.

### 1.2 Target group

---

This manual is for qualified electricians only who must perform the tasks exactly as described.

All persons installing inverters must be trained and experienced in general safety which must be observed when working on electrical equipments. Installation personnel should also be familiar with local requirements, rules and regulations.

### 1.3 Symbols used in this manual

---

The following safety precautions and general information are used in this manual:

**DANGER**

DANGER indicates a hazardous situation which, if not avoided, will result in death or serious injury.

**WARNING**

WARNING indicates a hazardous situation which, if not avoided, can result in death or serious injury.

**CAUTION**

CAUTION indicates a hazardous situation which, if not avoided, can result in minor or moderate injury.

**NOTICE**

NOTICE indicates a situation which, if not avoided, can result in property damage.



INFORMATION provides tips which are valuable for the optimal installation and operation of the inverter.

## 2 Safety

---

### 2.1 Intended use

---

1. IGPB converts the direct current from PV arrays into grid-compliant alternating current.
2. IGPB is suitable for indoor and outdoor use.
3. IGPB must only be operated with PV arrays (PV modules and cabling) of protection class II, in accordance with IEC 61730, application class A.  
Do not connect any sources of energy other than PV modules to the inverter.
4. PV modules with a high capacitance to ground may only be used if their coupling capacity does not exceed 1.0 $\mu$  F.
5. When the PV modules are exposed to sunlight, a DC voltage is supplied to this device.

### 2.2 Safety standards

---

IGPB complies with the EU Low-Voltage Directive 2006/95/EC and the EMC Directive 2004/108/EC. IGPB also complies with the requirement for safety and EMC in Australia and New Zealand market.

The inverters are labeled with the CE mark and RCM mark, fulfill the requirements specified in the specific standards.



## 2.3 Important safety information

---

### **DANGER**

- All work on the inverter must only be carried out by qualified personnel who have read and fully understood all safety information contained in this manual.
- Children must be supervised to ensure that they do not play with this device.

### **DANGER**

Danger to life due to high voltages of the PV array

When exposed to sunlight, the PV array generates dangerous DC voltage which is present in the DC conductors and the live components of the inverter. Touching the DC conductors or the live components can lead to lethal electric shocks. If you disconnect the DC connectors from the inverter under load, an electric arc may occur leading to electric shock and burns.

- Do not touch non-insulated cable ends.
- Do not touch the DC conductors.
- Do not touch any live components of the inverter.
- Have the inverter mounted, installed and commissioned only by qualified persons with the appropriate skills.
- If an error occurs, have it rectified by qualified persons only.
- Prior to performing any work on the inverter, disconnect it from all voltage sources as described in this documentation in chapter 8.

## **WARNING**

Risk of injury due to electric shock and fire caused by high leakage current

- The inverter must be reliably grounded in order to protect property and personal safety.

## **CAUTION**

Risk of injury due to hot heat sink

- The heat sink may get hot during operation. Do not touch!

## **CAUTION**

Possible damage to health as a result of the effects of electromagnetic radiation

- Please maintain a distance of at least 20cm from the inverter when it is in operation.

## **NOTICE**

Grounding the PV array

- Comply with local regulations for grounding the PV array. We suggest the frames of PV modules must be reliably grounded.
- Do not ground any of the terminals of the strings.

## **NOTICE**

Damage to the seal of the cover in sub-zero conditions









- If you open the cover in sub-zero condition, the sealing of the cover can be damaged. This can lead moisture entering the inverter.
- Do not open the inverter at ambient temperatures lower than  $-5^{\circ}\text{C}$ .
- If a layer of ice has formed on the seal of the cover in sub-zero conditions, remove it prior to opening the inverter (e.g. by melting the ice with warm air). Observe the applicable safety regulation.

## **NOTICE**

Damage to the inverter due to electrostatic discharge

- Touching electronic components can cause damage to or destroy the inverter through electrostatic discharge.
- Ground yourself before touching any component.

## 2.4 Symbols on the type label

Icon	Explanation
	<p>Risk of danger, warning and caution</p> <p>Safety information important for human safety. Failure to observe the safety information in this manual may result in injury or death.</p>
	<p>Danger to life due to electric shock</p> <p>The product operates at high voltages. Prior to performing any work on the product, disconnect the product from voltage sources. All work on the product must be carried out by electrically qualified persons only.</p>
	<p>Risk of burns due to hot surfaces</p> <p>The product can get hot during operation. Avoid contact during operation. Allow the product to cool down sufficiently before carrying out any work.</p>
	<p>WEEE designation</p> <p>Do not dispose of the product together with the household waste but in accordance with the disposal regulations for electronic waste applicable at the installation site.</p>
	<p>CE marking</p> <p>The product complies with the requirements of the applicable EU directives.</p>
	<p>RCM</p> <p>The product complies with the requirements of the applicable Australian low voltage and electromagnetic compatibility standards.</p>
	<p>Capacitors discharge</p> <p>Danger to life due to high voltages in the inverter, observe the waiting time of five minutes. Prior to performing any work on the inverter, disconnect it from all voltage sources as described in chapter 8.</p>
	<p>Observe the documentation</p> <p>Observe all documentation supplied with the product.</p>

## 2.5 Basic safety protection

---

We provide the following safety protection:

- 1) Overvoltage, undervoltage protection
- 2) Overfrequency, underfrequency protection
- 3) Overtemperature monitoring
- 4) Residual current monitoring
- 5) Isolation monitoring
- 6) Anti-islanding protection
- 7) DC feed-in monitoring

## 3 Unpacking

### 3.1 Scope of delivery

Object	Description	Quantity
A	Inverter	1
B	Wall bracket	1
C	Mounting accessory kit: Wall anchors and hexagon bolts (2×) M5×12 pan head screw (2×) *M5×14 pan head screw (1×) *Ground washer (2×)	1
D	DC connector	1
E	Documentation	1

\* One spare part for cover mounting



A

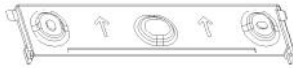

B



C



D

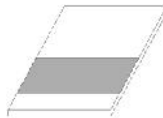

E



F

Please carefully check all of the components in the carton. If anything is missing, contact your dealer at once.

### 3.2 Checking for transport damage

Thoroughly inspect the packaging upon delivery. If you detect any damage to the packaging which indicates the inverter may have been damaged, inform the responsible shipping company immediately. We will be glad to assist you if required.

## 4 Mounting

### 4.1 Ambient conditions

1. Be sure the inverter is mounted out of the reach of children.
2. Mount the inverter in areas where it cannot be touched inadvertently.
3. Ensure good access to the inverter for installation and possible service.
4. The ambient temperature should be below 40°C to ensure optimal operation.
5. Observe the recommended clearances to walls, other inverters, or objects as follows to ensure sufficient heat dissipation.

Direction	Recommended clearance (mm)
above	300
below	300
sides	200

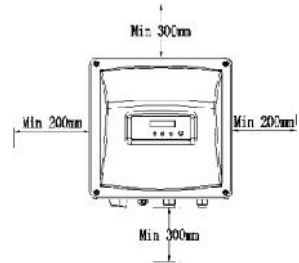

Clearances for one inverter

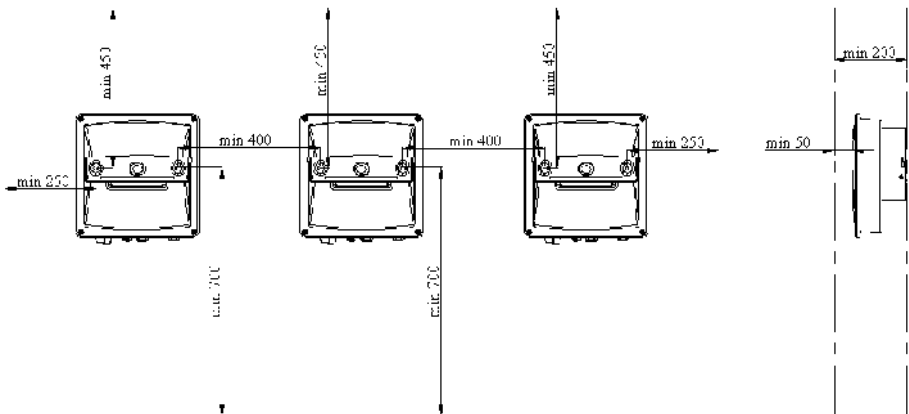

Clearances for multiple inverters

6. In order to avoid power reduction caused by overheating, do not mount the inverter in a location that allows long-term exposure to direct sunlight.

7. Ensure optimum operation and extend service life, avoid exposing the inverter to direct sunlight, rain and snow.

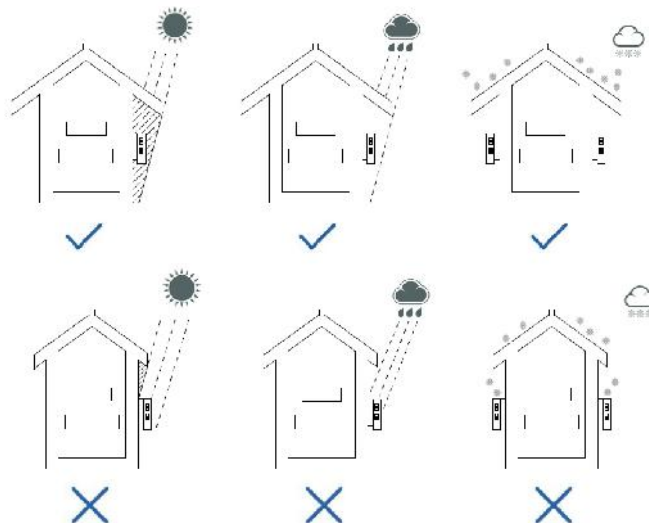

8. The mounting method, location and surface must be suitable for the inverter's weight and dimensions.
9. If mounted in a residential area, we recommend mounting the inverter on a solid surface. Plasterboard and similar materials are not recommended due to audible vibrations when in use.
10. Do not put any objects on the inverter. Do not cover the inverter.



## 4.2 Selecting the mounting location

### DANGER

Danger to life due to fire or explosion

- Do not mount the inverter on flammable construction materials.
- Do not mount the inverter in areas where flammable materials are stored.
- Do not mount the inverter in areas where there is a risk of explosion.

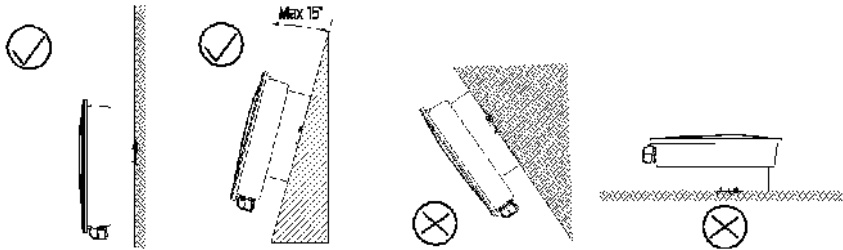

1. Mount the inverter vertically or tilted backward by a max of 15°.
2. Never mount the inverter tilted forward or sideways.
3. Never mount the inverter horizontally.
4. Mount the inverter at eye level to make it easy to operate and to read the display.
5. The electrical connection area must point downwards.

### 4.3 Mounting the inverter with the wall bracket

#### CAUTION

Risk of injury when lifting the inverter, or if it is dropped

The inverter weighs approximately 8 kg. There is risk of injury if the inverter is lifted incorrectly or dropped while being transported or when attaching it to or removing it from the wall bracket.

- Transport and lift the inverter carefully

#### CAUTION

Risk of injury due to damaged cables

There may be power cables or other supply lines (e.g. gas or water) routed in the wall.

- Ensure that no lines are laid in the wall which could be damaged when drilling holes.

Mounting procedures:

1. Use the wall bracket as a drilling template and mark the positions of the drill holes, then drill 2 holes (  $\varnothing 10$  ) to a depth about 70mm. During operation, keep the drill vertical to the wall, and hold the drill steady to avoid tilted holes.
2. After cleaning the dust and other objects from the holes, place 2 wall anchors into the holes, then attach the wall bracket to the wall using the hexagon head screw delivered with the inverter.

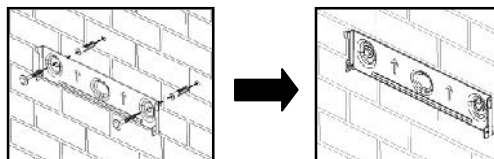
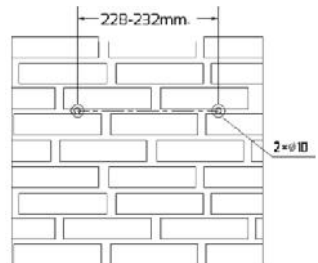

3. Holding the inverter using the housing side edges and attach it onto the wall bracket tilted slightly downwards.

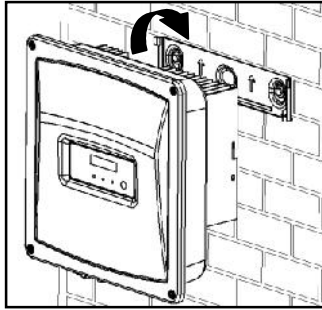

4. Check both sides of the heatsink to ensure that it is securely in place.

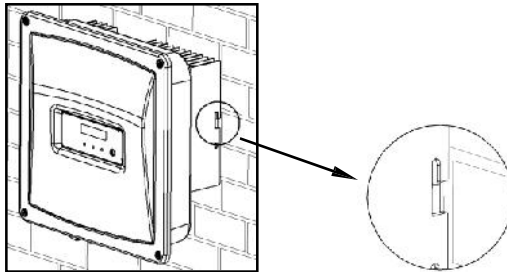

5. Push the inverter as far as possible and attach it to both sides of the wall bracket using the M5 screws.(screw driver type: T25,torque: 2.5Nm)

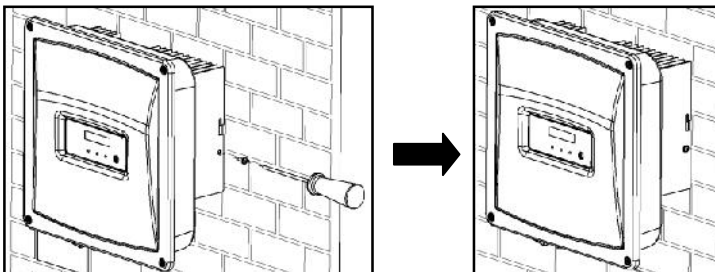

If a second protective conductor is required in installation site, ground the inverter and secure it so that it cannot be lifted off the wall bracket (see section 5.4.3 Second protective grounding connection“).

Dismante the inverter in reverse order.

## 5 Electrical connection

---

### 5.1 Safety

---

#### **DANGER**

Danger to life due to high voltages of the PV array

When exposed to sunlight, the PV array generates dangerous DC voltage which is present in the DC conductors and the live components of the inverter. Touching the DC conductors or the live components can lead to lethal electric shocks. If you disconnect the DC connectors from the inverter under load, an electric arc may occur leading to electric shock and burns.

- Do not touch non-insulated cable ends.
- Do not touch the DC conductors.
- Do not touch any live components of the inverter.
- Have the inverter mounted, installed and commissioned only by qualified persons with the appropriate skills.
- If an error occurs, have it rectified by qualified persons only.
- Prior to performing any work on the inverter, disconnect it from all voltage sources as described in chapter 8.

## WARNING

Risk of injury due to electric shock

- The external protective grounding conductor is connected to the inverter's protective grounding terminal through the screw terminal block. Make sure the connection is reliable.
- When connecting, connect the AC connection first to ensure the inverter grounding reliably and then connect the DC inputs.
- When disconnecting, disconnect the DC inputs first and then disconnect the AC connection.
- Don't connect the DC inputs while the AC connection is disconnected under any circumstances.
- All electrical installations must be done in accordance with the National Wiring Rules Standards and Local Code.

## 5.2 System layout of units without integrated DC switch

Local standards or codes may require that PV systems are fitted with an external DC switch on the DC side. The DC switch must be able to safely disconnect the open-circuit voltage of the PV array plus a safety reserve of 20%.

Install a DC switch to each PV string to isolate the DC side of the inverter. We recommend the following electrical connection:

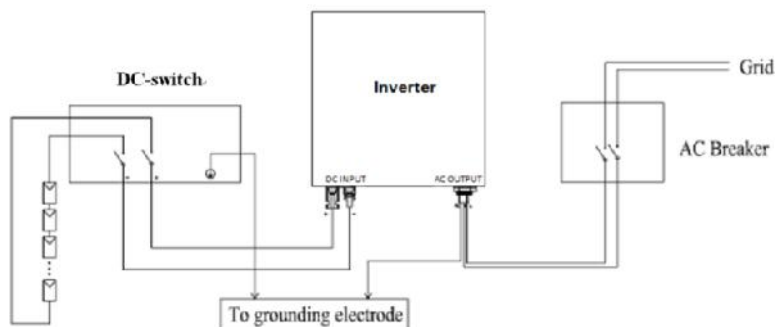

### 5.3 Overview of the connection area

---

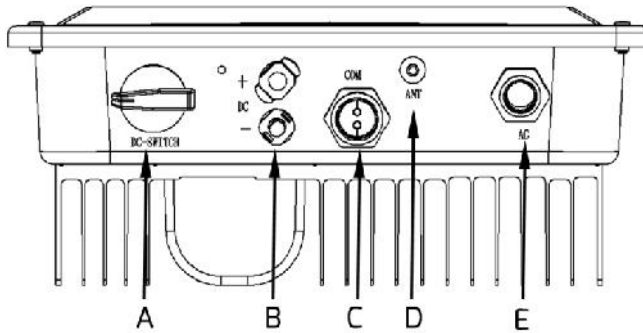

Object	Description
A	DC-SWITCH (optional): switch on or off for PV-load.
B	DC: plug-in connector to connect the strings.
C	COM: connect the monitoring device with network cable.
D	ANT (optional): antenna, transmit and receive Wi-Fi signal.
E	AC: connect the grid.

## 5.4 AC connection

### DANGER

Danger to life due to high voltages in the inverter

- Before performing the electrical connection, ensure that the AC circuit breaker is switched off and cannot be reactivated.

### 5.4.1 Conditions for the AC connection

#### Cable Requirements

The grid connection is established using three conductors (L, N, and PE).

We recommend the following requirements for stranded copper cable.

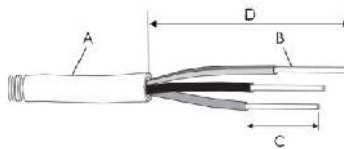

Object	Description	Value
A	External diameter	5 to 13 mm
B	Conductor cross-section	2.5 to 6 mm <sup>2</sup>
C	Stripping length of the insulated conductors	approx. 12 mm
D	Stripping length of the outer sheath of AC cable	approx. 70 mm
The PE insulated conductor must be 10mm longer than the L and N conductors		

Larger cross-sections should be used for longer leads.

#### Cable design

The conductor cross-section should be dimensioned to avoid power loss in cables exceeding 1% of rated output power.

The higher grid impedance of the AC cable makes the inverter easier to disconnect from the grid due to excessive voltage at the feed-in point.

The maximum cable lengths relative to the conductor cross-section as follows:

Conductor cross-section	Maximum cable length			
	IGPB 1000	IGPB 1500	IGPB 2000	IGPB 3000
2.5 mm <sup>2</sup>	46m	37 m	28 m	17 m
4 mm <sup>2</sup>	74 m	59 m	44 m	27 m
6 mm <sup>2</sup>	110 m	89 m	67 m	40 m

The required conductor cross-section depends on the inverter rating, ambient temperature, routing method, cable type, cable losses, applicable installation requirements of the country of installation, etc.

#### 5.4.2 Grid connection

### **WARNING**

Risk of injury due to electric shock and fire caused by high leakage current

- The inverter must be reliably grounded in order to protect property and personal safety.

### **NOTICE**

Damage to the seal of the cover in sub-zero conditions

- If you open the cover in sub-zero condition, the sealing of the cover can be damaged. This can lead moisture entering the inverter.
- Do not open the inverter at ambient temperatures lower than -5°C.
- If a layer of ice has formed on the seal of the cover in sub-zero conditions, remove it prior to opening the inverter( e.g. by melting the ice with warm air ). Observe the applicable safety regulation.



Procedure:

1. Switch off the AC circuit breaker and secure it against reconnection.
2. Loosen the screws of the cover using a screwdriver (T25) and remove the cover.

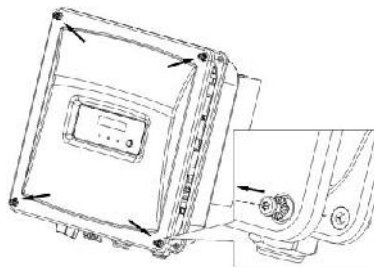

loosen the screws of the cover

During loosening the screws of the cover, it is not necessary to take off the screws and conical spring washers, which can remain on the cover and will not fall off.

3. Strip the AC cable's outer sheath 70 mm. Shorten L and N by 10 mm each. Strip the insulation of L, N, and PE conductor by 12 mm.

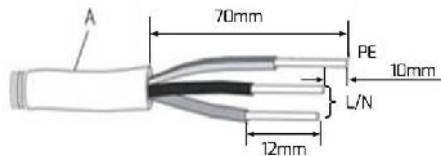

4. Route the AC cable into the inverter through the M20 cable gland.
5. If necessary, slightly loosen the swivel nut of the cable gland.
6. Insert bared conductor into the cord end terminal and crimp the contact.

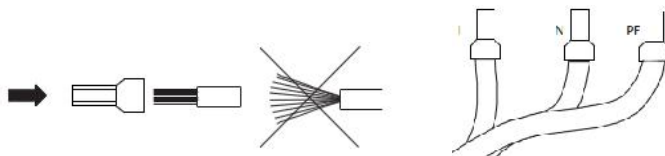

7. Connect the L,N,protective conductor(PE) to the screw terminal block(screw driver type:DIN5264(blade: 1×5.5),torque: 1.2Nm).
  - Insert the protective conductor (green-yellow) into the screw terminal with the grounding sign and tighten the screw.
  - Insert the neutral conductor (blue) into the screw terminal with N sign and tighten the screw.
  - Insert the L conductor (brown or black) into the screw terminal with L sign and tighten the screw.

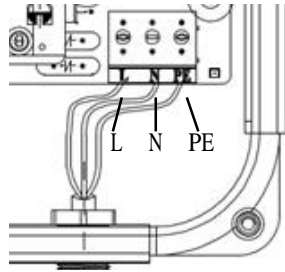

8. Make sure the insulated conductors are securely connected.
9. Tighten the swivel nut of the cable gland by using a torque of 2.5Nm and check the tightness.
10. Secure the cover in the sequence 1 to 4 (screw driver type: T25,torque: 2.2Nm).

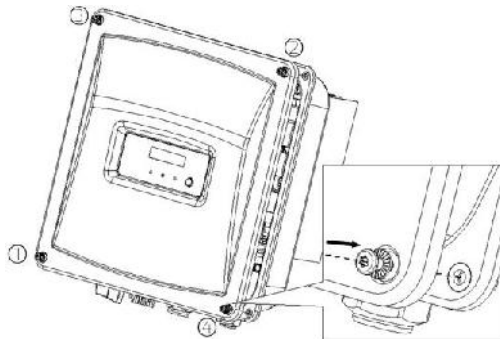

### 5.4.3 Second protective grounding connection

---

If required, the grounding terminal can be used to connect a second protective conductor or as equipotential bonding.

Procedure:

1. Take out the terminal lug, insert the stripped grounding conductor into the terminal lug and crimp the contact.
2. Align the plain washer, the terminal lug with the grounding conductor, and the ground washer on the screw. The teeth of the ground washer must be facing the heat sink.
3. Insert the screw through the hole at the side of the heat sink, and tighten it firmly into the wall bracket (screw driver type: T25,torque: 2.5Nm).

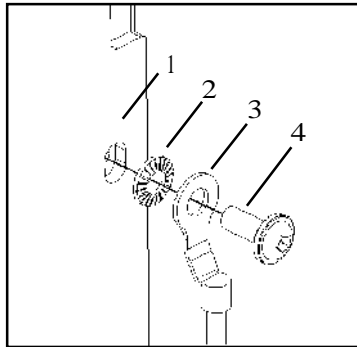

Grounding parts information:

Object	Description
1	Heatsink
2	Ground washer
3	Terminal lug(M5) with protective conductor
4	M5×12 pan head screw

#### 5.4.4 Residual current protection

---

The inverter is equipped with an all-pole sensitive residual current monitoring unit (RCMU) with an integrated differential current sensor which fulfills the requirements of DIN VDE 0100-712 (IEC60364-7-712:2002).

Therefore an external residual current device (RCD) is not required. If an external RCD needs to be installed because of local regulations, a RCD type A or type B can be installed as an additional safety measure.

The all-pole sensitive residual current monitoring unit (RCMU) detects alternating and direct differential currents. The integrated differential current sensor detects the current difference between the neutral conductor and the line conductor. If the current difference increases suddenly, the inverter disconnects from the grid. The function of the all-pole sensitive residual current monitoring unit (RCMU) has been tested in accordance with IEC 62109-2.



#### Tip about the external residual current device (RCD)

Where an external residual current device (RCD) is required in a TT or TN-S system, install a residual current device which trips at a residual current of 100mA or higher.

For each connected inverter, a rated residual current of 100mA has to be provided. The rated residual current of the RCD must be equal to at least the sum of the rated residual currents of the connected inverter. That means that, if, for example, 2 transformerless inverters are connected, the rated residual current of the RCD must be at least 200mA.

### 5.4.5 Overvoltage category

The inverter can be deployed in grids of installation category III or lower, as defined under IEC 60664-1. This means that it can be permanently connected at the grid-connection point in a building. In installations involving long outdoor cable routing, additional overvoltage-reducing measures must be taken so that the overvoltage category is reduced from IV to III.

### 5.4.6 Rating of AC circuit breaker



**Danger to life due to fire**

You must safeguard each inverter with an individual AC circuit breaker in order that the inverter can be disconnected safely.

No consumer load should be applied between AC circuit breaker and the inverter. Use dedicated AC circuit breakers with load switch functionality for load switching. The selection of the AC circuit breaker rating depends on the wiring design (wire cross-section area), cable type, wiring method, ambient temperature, inverter current rating etc. Derating of the circuit breaker rating may be necessary due to self-heating or if exposed to heat.

The maximum output currents of the inverters and recommended AC circuit breaker can be found in the following table.

Type	IGPB 1000	IGPB 1500	IGPB 2000	IGPB 3000
Max. output current	5.5A	7.5 A	10 A	15 A
Recommended fuse type gL/gG or comparable circuit breaker rating	16 A	16 A	16 A	25A

## 5.5 DC connection

---

### DANGER

Danger to life due to high voltages in the inverter

- Before connecting the PV array, ensure that the DC switch is switched off and that it cannot be reactivated.
- Do not disconnect the DC connectors under load.

### 5.5.1 Requirements for the DC connection

---



Use of Y adapters for parallel connection of strings

The Y adapters must not be used to interrupt the DC circuit.

- Do not use the Y adapters in the immediate vicinity of the inverter. The adapters must not be visible or freely accessible.
- In order to interrupt the DC circuit, always disconnect the inverter as described in this document in chapter 8.

Requirements for the PV modules of a string:

- PV modules of the connected strings must be of: the same type, identical alignment and identical tilt.
- The thresholds for the input voltage and the input current of the inverter must be adhered to (see Section 10.1 "Technical DC input data").
- On the coldest day based on statistical records, the open-circuit voltage of the PV array must never exceed the maximum input voltage of the inverter.
- The connection cables of the PV modules must be equipped with the connectors included in the scope of delivery.
- The positive connection cables of the PV modules must be equipped with the positive DC connectors. The negative connection cables of the PV modules must be equipped with the negative DC connectors

## 5.5.2 Assembling the DC connectors

### DANGER

Danger to life due to high voltages on DC conductors

When exposed to sunlight, the PV array generates dangerous DC voltage which is present in the DC conductors. Touching the DC conductors can lead to lethal electric shocks.

- Cover the PV modules.
- Do not touch the DC conductors.

Assemble the DC connectors as described below. Be sure to observe the correct polarity. The DC connectors are marked with the symbols "+" and "-".

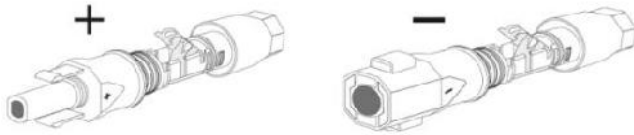

Cable requirements:

The cable must be of type PV1-F, UL-ZKLA or USE2 and comply with the following properties:

- ◇ External diameter: 5 mm to 8 mm
- ◇ Conductor cross-section: 2.5 mm<sup>2</sup> to 6 mm<sup>2</sup>
- ◇ Qty single wires: minimum 7
- ◇ Nominal voltage: minimum 600V

Proceed as follows to assemble each DC connector:

1. Strip 12 mm off the cable insulation.

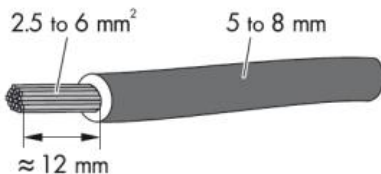

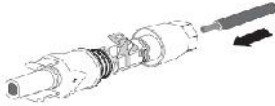

2. Route the stripped cable all the way into the DC connector. Ensure that the stripped cable and the DC connector have the same polarity.

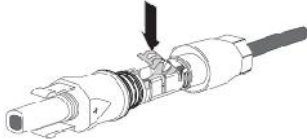

3. Press the clamping bracket down until it audibly snaps into place.

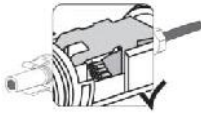

4. Ensure that the cable is correctly positioned:

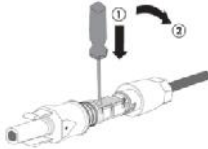
Result	Measure
<p>If the stranded wires are visible in the chamber of the clamping bracket, the cable is correctly positioned.</p> 	<ul style="list-style-type: none"> <li>• Proceed to step 5.</li> </ul>
<p>If the stranded wires are not visible in the chamber, the cable is not correctly positioned.</p> 	<ul style="list-style-type: none"> <li>• Release the clamping bracket. To do so, insert a flat-blade screwdriver (blade width: 3.5 mm) into the clamping bracket and lever it open.</li> </ul>  <ul style="list-style-type: none"> <li>• Remove the cable and go back to step 2.</li> </ul>

5. Push the swivel nut up to the thread and tighten (torque: 2 Nm).





### 5.5.3 Disassembling the DC connectors

#### DANGER

Danger to life due to high voltages on DC conductors

When exposed to sunlight, the PV array generates dangerous DC voltage which is present in the DC conductors. Touching the DC conductors can lead to lethal electric shocks.

- Cover the PV modules.
- Do not touch the DC conductors.

1. Unscrew the swivel nut.



2. To release the DC connector, insert a flat-blade screwdriver (blade width: 3.5 mm) into the side catch mechanism and lever open.

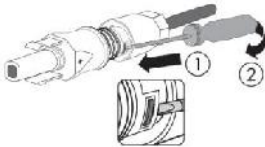

3. Carefully pull the DC connector apart.



4. Release the clamping bracket. To do so, insert a flat-blade screwdriver (blade width: 3.5 mm) into the clamping bracket and lever it open.

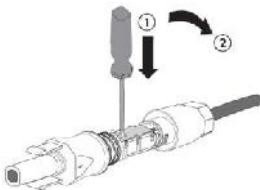

5. Remove the cable.

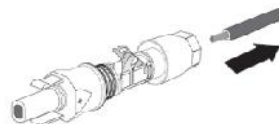

## 5.5.4 Connecting the PV array

### **NOTICE**

Damage to the inverter due to overvoltage

If the voltage of the strings exceeds the maximum DC input voltage of the inverter, it can be destroyed due to overvoltage. All warranty claims become void.

- Do not connect strings with an open-circuit voltage greater than the maximum DC input voltage of the inverter.
- Check the design of the PV system.

1. Ensure that the individual AC circuit breaker is switched off and ensure it against reconnection.

2. Ensure that the DC switch is switched off and ensure it against reconnection.

3. Ensure that there is no ground fault in the PV strings.

4. Check whether the DC connector has the correct polarity.

If the DC connector is equipped with a DC cable having the wrong polarity, the DC connector must be reassembled. The DC cable must always have the same polarity as the DC connector.

5. Ensure that the open-circuit voltage of the PV strings does not exceed the maximum DC input voltage of the inverter.

6. Connect the assembled DC connectors to the inverter until they audibly snap into place. Ensure that all DC connectors are securely in place.

## 6 Communication

---

Pinout detail of the RJ45 interface on the inverter as follows:

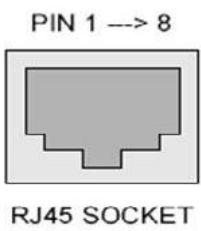
Pin1----- TX_RS485A	
Pin2-----TX_RS485B	
Pin3-----RX_RS485A	
Pin4-----GND	
Pin5-----GND	
Pin6-----RX_RS485B	
Pin7-----+7V	
Pin8-----+7V	

For detailed information, please refer to NovergyManager user manual.

**CAUTION**

CAT-5 with shield or higher level cable is required as the RS485 communication cable between inverter. Pinout detail on both ends of the cable should comply with I A/TIA568A or 568B standard.

The cable shall be UV resistant if used outdoors.

Connect the network cable:

**NOTICE**

Damage to the inverter due to moisture and dust penetration





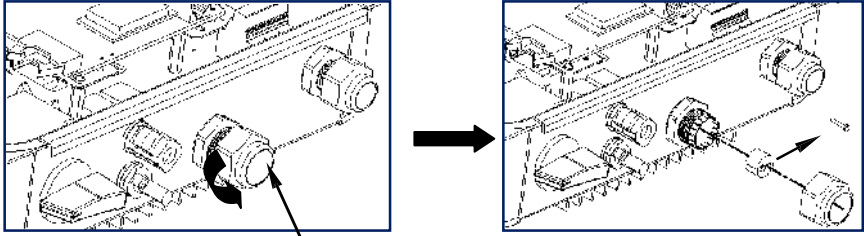







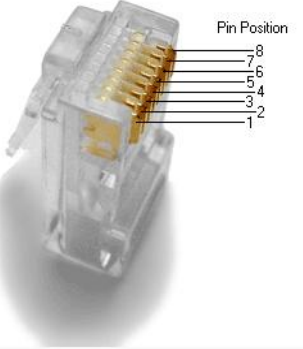



- If the cable gland are not mounted properly, the inverter can be destroyed due to moisture and dust penetration. All the warranty claim will be invalid.
- Make sure the cable gland has been tightened firmly.

1. Loosen the screws of the cover using a screwdriver (T25) and remove the cover. (see Section 5.4.2).
2. Unscrew the swivel nut of the M25 cable gland, remove one filler-plug from the cable gland and keep it well. If there is only one network cable, please keep another filler-plug in the remaining hole of the sealing ring against water ingress.



M25 cable gland for network cable

3. The current pinout assignment for network cable complies with the EIA/TIA 568 standard. Please refer and apply it for physical implementation as needed.

Pin	T568A Color	T568B Color	Pins on plug face (socket is reversed)
1	 white/green stripe	 white/orange stripe	
2	 green solid	 orange solid	
3	 white/orange stripe	 white/green stripe	
4	 blue solid	 blue solid	
5	 white/blue stripe	 white/blue stripe	
6	 orange solid	 green solid	
7	 white/brown stripe	 white/brown stripe	
8	 brown solid	 brown solid	

4. Route the network cable into the inverter through the M25 cable gland, and connect it to the RJ45 socket located on the lower circuit board.

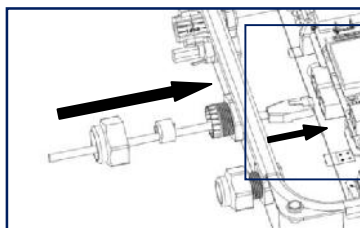

If the inverter has integrated ComBox (with Ethernet module), you need to insert the network cable into the RJ45 socket on the upper circuit board(ComBox).

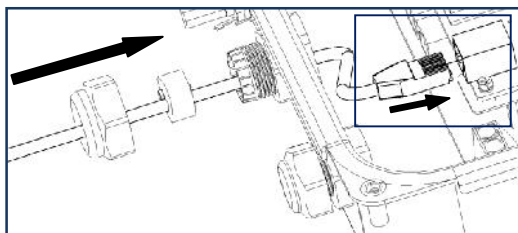

5. Connect the inverter via the above mentioned network cable.

6. Press the sealing ring with the network cable into the cable gland, and then tighten the swivel nut firmly. Make sure the cable gland is mounted properly. The cable gland must be adequately locked to prevent any movement of the cable.

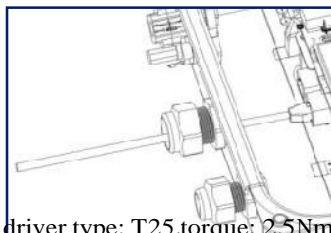

7. Secure the cover (screw driver type: T25,torque: 2.5Nm).

Disassemble the network cable in reverse order.

## 6.4 Communication with a third-party devices

---

This interver supports communication with a third party monitoring device such as Metecontrol, Solar-Log etc. For detailed wiring method please refer to operating manual of corresponding third party monitoring device.

## 7 Commissioning

---

### **NOTICE**

Risk of injury due to incorrect installation

We strongly recommend carrying out preliminary checks before commissioning to avoid possible damage to the device caused by faulty installation.

### 7.1 Electrical checks

---

Carry out the main electrical checks as follows:

- ① Check the PE connection with a multimeter: check that the inverter's exposed metal surface has a ground connection.

### **DANGER**

Danger to life due to the presence of DC voltage

- Only touch the insulation of the PV array cables.
- Do not touch parts of the sub-structure and frame of PV array which are not grounded.
- Wear personal protective equipment such as insulating gloves.

- ② Check the DC voltage values: check that the DC voltage of the strings does not exceed the permitted limits.
- ③ Check the polarity of the DC voltage: make sure the DC voltage has the correct polarity.
- ④ Check the PV array's insulation to ground with a multimeter: make sure that the insulation resistance to ground is greater than 1 MOhm.





**DANGER**

Danger to life due to the presence of AC voltage

- Only touch the insulation of the AC cables.
- Wear personal protective equipment such as insulating gloves.

- ⑤ Check the grid voltage: check that the grid voltage at the point of connection of the inverter complies within the permitted value.

## 7.2 Mechanical checks

---

Carry out the main mechanical checks to ensure the inverter is waterproof:

- ① Make sure the inverter and wall bracket have been correctly mounted.
- ② Make sure the cover has been correctly mounted.
- ③ Make sure the communication and AC cable glands have been correctly mounted and tightened.

### 7.3 Start-up

---

After finishing the electrical and mechanical checks, switch on the AC circuit breaker and DC switch in turn. Once the DC input voltage and power are sufficiently high and the grid-connection conditions are met, the inverter will start operation automatically. Usually, there are three states during operation:

**Waiting:** When the initial voltage of the strings is greater than the minimum DC input voltage but lower than the start-up DC input voltage, the inverter is waiting for sufficient DC input voltage and cannot feed power into the grid.

**Checking:** When the initial voltage of the strings exceeds the start-up DC input voltage, the inverter will check feeding conditions at once. If there is anything wrong during checking, the inverter will switch to the "Fault" mode.

**Normal:** After checking, the inverter will switch to "Normal" state and feed power into the grid.

During periods of low radiation, the inverter may continuously start up and shut down. This is due to insufficient power generated by the PV generator.

If this fault occurs often, please call service.



#### Quick Troubleshooting

If the inverter is in "Fault" mode, refer to Section 11 "Troubleshooting".

## 8 Disconnecting the inverter from voltage sources

Prior to performing any work on the inverter, disconnect it from all voltage sources as described in this section. Always adhere strictly to the prescribed sequence.

### **NOTICE**

Destruction of the measuring device due to overvoltage

- Only use measuring devices with a DC input voltage range of 1000 V or higher.

Procedure:

1. Disconnect the AC circuit breaker and secure it against reconnection.
2. Disconnect the DC switch and secure it against reconnection.
3. Use a current clamp to ensure that no current is present in the DC cables.
4. Release and remove all DC connectors. Insert a flat-blade screwdriver or an angled screwdriver (blade width: 3.5 mm) into one of the slide slots and pull the DC connectors out downwards. Do not pull on the cable.

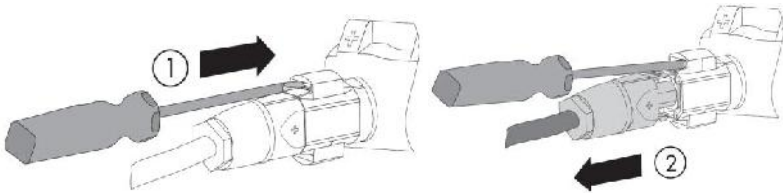

5. Ensure that no voltage is present at the DC input of the inverter using a suitable measuring device.

### **⚠ DANGER**

Danger to life due to high voltages

The capacitors in the inverter take 5 minutes to discharge.

- Wait 5 minutes before opening the cover.

6. Loosen the screws of the cover using a screwdriver (T25) and remove the cover.

## **NOTICE**

Damage to the inverter due to electrostatic discharge

- Touching electronic components can cause damage to or destroy the inverter through electrostatic discharge.

7. Use a suitable measuring device to check that no voltage is present at the AC screw terminal blocks between L and N and L and PE.
8. Unscrew the screws of the screw terminal blocks and the swivel nut of the M20 cable gland, remove the AC cable .
9. Secure the cover (screw driver type: T25,torque: 2.5Nm).

## 9 Operation

---

The information provided here covers the LED indicators, control button, display messages, and the language and safety regulation settings.

### 9.1 Overview of the control panel

---

The inverter is equipped with a text display, three LEDs indicators and one control button.

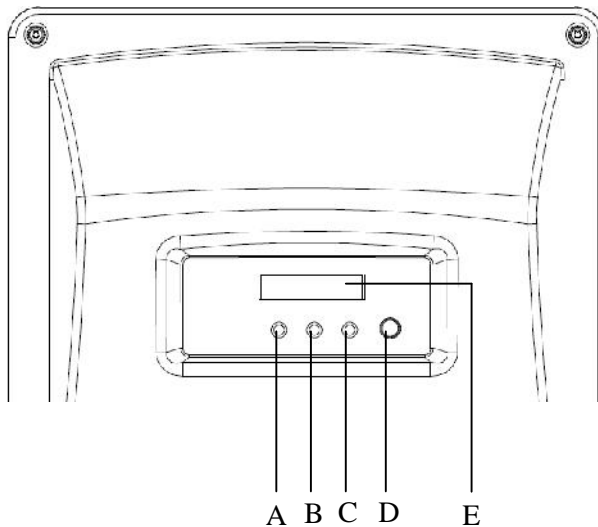

Object	Description
A	Normal (Green LED)
B	Fault (Red LED)
C	Communication (Yellow LED)
D	Control button
E	Display

## 9.1.1 Display

The display consists of 16 characters × 2 lines. The bottom line always shows the current output (Pac = xxxx.xW). The top line shows the current state by default, it will switch to different running information by pressing the control button, as follows. For the IP Addr item, the top line displays ComBox IP addr (it will show 0.0.0.0 without integrated ComBox), and the bottom line displays state whether or not the inverter has connected to Solarcloud.

Line 1	<pre> graph TD     A[Running information] --&gt; B[E-today]     B --&gt; C[E-total]     C --&gt; D[Vpv]     D --&gt; E[Ipv]     E --&gt; F[Vac]     F --&gt; G[Iac]     G --&gt; H[Frequency]     H --&gt; I[Model]     I --&gt; J[Set Language]     J --&gt; K[Version Serial]     K --&gt; L[No.]     L --&gt; M[IP Addr]     </pre>	<p>Daily energy</p> <p>Energy generated since the inverter has been installed</p> <p>DC input voltage</p> <p>DC input current</p> <p>Grid voltage</p> <p>Present output current</p> <p>Grid frequency</p> <p>Type name</p> <p>Selected language</p> <p>Firmware version</p> <p>Serial number</p> <p>ComBox IP addr<sup>(1)</sup></p>
Line 2	<p>Pac = xxxx.xW</p> <p>connect state</p>	<p>Current output power</p> <p>Connect solarcloud or not</p>

- (1) If the inverter is connected with external communication devices (e.g. NovergyCom, NovergyManager, or other 3rd party devices), please read the IP address on these devices. The inverter will always show the IP address and state of the integrated communication module only, i.e. if no ComBox integrated inside the inverter, 0.0.0.0 'Disconnected' accordingly.

## 9.1.2 Control button

---

The inverter has a control button which is necessary to switch between the various displays for measured values and data, enter next entry and lock the expected information.

The display menus wrap around, which means that when you arrive at the last entry, the first entry is displayed when you press the button again.

You can freeze the display as follows:

Press the button for 5s when it shows the information you desire, and do not release the button until you see "LOCK". The display will show the selected information until you press the button again or the operating state of the inverter changes.

To save power, the backlight of the display turns off automatically after 10s. Press the button again to activate it.

## 9.1.3 LEDs

---

The inverter is equipped with three LED indicators "green", "red" and "yellow" which provide information about the various operating states.

Green LED:

The green LED is lit when the inverter is operating normally.

Yellow LED:

The yellow LED flashes during communication with other devices e.g. NovergyCom/NovergyManager, Solarlog etc. Also, the yellow LED flashes during updating firmware through RS485.

Red LED:

The red LED is lit when the inverter has stopped feeding power into the grid due to a fault. The corresponding error code will be shown on the display.

## 9.2 Display messages

Along with the various operating states, various messages may be shown on the display, as follows.

State	Error code	Description	Causes
Initializat- ion		Waiting	Initial PV voltage is between minimum DC input voltage and the start-up DC input voltage of the inverter.
		Checking	The inverter is checking the feed-in conditions after the start-up PV voltage exceeds the initial DC input voltage of the inverter and that both the grid voltage and frequency are normal .
		Reconnect	The inverter is checking feed-in conditions after the last fault has been solved.
Normal		Normal	The inverter is feeding energy into grid normally.
fault	1	SCI Fault	Communication between the master and slave CPU has failed.
	2	EEPROM R/W Fault	Reading or writing of EEPROM has failed.
	3	Rly-Check Fault	Output relay has failed.
	4	DC INJ. High	Output DC feed-in exceeds the permitted upper limit.
	6	High DC Bus	The voltage of DC bus exceeds the permitted upper limit.
	8	AC HCT Fault	Output current is abnormal
	9	GFCI Fault	Ground fault detection circuit is abnormal
	10	Device Fault	Unknown Error
	33	Fac Fault	The grid frequency is outside the permitted range.



fault	34	Vac Fault	The grid voltage is outside the permitted range.
	35	No Utility Grid Available	The utility cannot be detected, which may be caused by no utility, grid disconnected, AC cables damaged, fuse broken or island mode.
	36	Residual current fault	The residual current exceeds the permitted upper limit.
	37	PV Overvoltage	The voltage of the strings exceeds the permitted upper limit.
	38	ISO Fault	The PV array's insulation resistance to ground is below the permitted value, or the electrical insulation inside the inverter has failed.
	40	Over Temp.	The internal temperature exceeds the permitted value.
	41	Vac differs for M-S	A different value of grid voltage has been detected by the master and slave MCU.
	42	Fac differs for M-S	A different value of grid frequency has been detected by the master and slave MCU.
	43	Residual current differs for M-S	A different value of residual current has been detected by the master and slave MCU.
	44	DC Inj. differs for M-S	A different value of DC feed-in has been detected by the master and slave MCU.
45	Fac,Vac differs for M-S	A different value of grid frequency and voltage has been detected by the master and slave MCU.	

The last five failure reports on the network and system protection device can be read. An interruption in the supply voltage of 3s does not result in any loss of failure reports (according to VDE-AR-N 4105).

## 9.3 Language and safety regulation settings

---

Before setting, switch on the DC switch, and ensure that the AC circuit breaker is switched off and cannot be reactivated, while the inverter should be reliably grounded.

### 9.3.1 Language setting

---

The inverter provides two languages: English and German.

Press the button for approx. 5s at the entry of "Set Language" to enter the language menu and select the language. The display will switch to current state information automatically and the language setting will be saved at the same time unless you press the button again within approximately 10s.

### 9.3.2 Safety regulation setting

---

There is a safety regulation setting function in the inverter. You can choose different safety regulations according to the local requirements. If the inverters are installed in Germany or Australia, you don't need to set the safety regulation again because the default setting is correct for these two countries. Set the safety regulation as described below:

Step 1:

Connect the inverter to the PV generator, switch on the DC switch; the LCD displays the following:

Error Code: 35 Pac= 0.0W
-----------------------------

Step 2:

Press the control key (see section 9.1.1) approx. once per second until the LCD display shows:

ZL xxxxS Pac= 0.0W
-----------------------

Then press the control key for 10 seconds. The LCD will show the safety regulation as illustrated below:

DE VDE-AR-N 4105 means the German safety regulation (VDE4105)

DE VDE-AR-N 4105 Pac= 0.0W
-------------------------------

Step 3:

Before the display goes out from above mentioned step 2, press the control key again once a second to scroll to the safety regulations you want.

For example, if you want to choose the safety regulation for the Netherlands, press the control key until the display shows NL NEN50438“ as below:

NL NEN50438 Pac= 0.0 W
---------------------------

Wait about 10 seconds. When the display goes out, the safety regulation setting has completed.

Comment:

- 1 If the display shows DEFAULT“, keep on pressing the control button until the display shows the desired safety regulation.
- 2 To set other safety regulations, please refer to the example of setting the Netherlands

## 10 Technical Data

---

### 10.1 DC input data

---

Type	IGPB 1000	IGPB 1500	IGPB 2000	IGPB 3000
Max DC convertible power (@cos $\phi$ =1)	1150W	1750W	2350W	3150W
Max. input voltage	500V			600V
MPP voltage range	70-450V			70-520V
Rated input voltage	360V			
Min. start voltage	80V			
Min. feed-in power	6W			
Max. input current	11A			
Number of independent MPP inputs	1			
Strings per MPP tracker	1			

## 10.2 AC output data

Type	IGPB 1000	IGPB 1500	IGPB 2000	IGPB 3000
Rated active power	1000W	1500W	2000W	3000W
Max. apparent AC power	1100VA	1650VA	2200VA	3000 VA
Nominal AC voltage / range	220V,230V,240V / 180V-280V			
AC power frequency / range	50,60 / $\pm 5$ Hz			
Max. output current	5.5A	7.5A	10A	15A
Power factor (@rated power)	1			
Adjustable displacement power factor(only for VDE4105)	0.95 <sub>inductive</sub> ...1... 0.95 <sub>capacitive</sub>			
Adjustable displacement power factor	0.8 <sub>inductive</sub> ...1... 0.8 <sub>capacitive</sub>			
Feed-in phases / connection phases	1 / 1			
Harmonic distortion (THD) at rated output	< 3%			

### 10.3 General data

Type	IGPB 1000	IGPB 1500	IGPB 2000	IGPB 3000
communication <sup>1)</sup> : RS485 / Ethernet / WiFi	/ /			
Display	16 x 2 characters			
Dimensions (W x H x D)	346 x 346 x 132mm			346 x 346 x 146mm
Weight	7Kg			7.5Kg
Cooling concept	convection			
Noise emission (typical)	< 15 dB(A)@1m			
Installation	indoor & outdoor			
Mounting information	wall mounting bracket			
DC connection technology	SUNCLIX			
AC connection technology	screw clamp terminal			
Operating temperature range	-25°C...+60°C / -13°F...+140°F			
Relative humidity (non-condensing)	0% ... 100%			
Max. operating altitude	4000m(>3000m derating)			
Degree of protection (according to IEC 60529)	IP65			
Climatic category (according to IEC 60721-3-4)	4K4H			
Topology	H5			
Self-consumption (night)	<1W			
Standby power	<6W			

—Standard

—Optional

--N/A

## 10.4 Safety regulations

Type	IGPB 1000	IGPB 1500	IGPB 2000	IGPB 3000
DC switch				
PV iso / Grid monitoring	/			
DC reverse polarity protection / AC short- circuit current capability	/			
Residual current monitoring(GFCI) function				
Protection class (according to IEC 62103) / overvoltage category (according to IEC 60664-1)	I / II(DC), III(AC)			
Internal overvoltage protection	Integrated			
DC feed-in monitoring	Integrated			
Islanding protection	Integrated			
EMC immunity	EN61000-6-1, EN61000-6-2			
EMC emission	EN61000-6-3, EN61000-6-4			
Utility interference	EN61000-3-2, EN61000-3-3			

—Standard

—Optional

--N/A



### Information for choosing the safety standard VDE-AR-N 4105

If a central network and system protection device is used for power generation systems, the value of the rise-in-voltage protection  $U_{>}$  of 1.1 $U_n$  presented in the integrated network and system protection can be changed, but a password is required. It is not necessary to adjust the value of the displacement power factor  $\cos(\phi)$  if the power generation system is  $S_{Amax}$   $A_{max}$  generation s set to 1 as default in the embedded inverter software.



## 10.6 Power reduction

In order to ensure inverter operation under safe conditions, the device may automatically decrease power output.

Power reduction depends on many operating parameters including ambient temperature and input voltage, grid voltage, grid frequency and power available from the PV modules. This device can decrease power output during certain periods of the day according to these parameters.

Notes: Values are based on rated grid voltage and  $\cos(\phi) = 1$ .

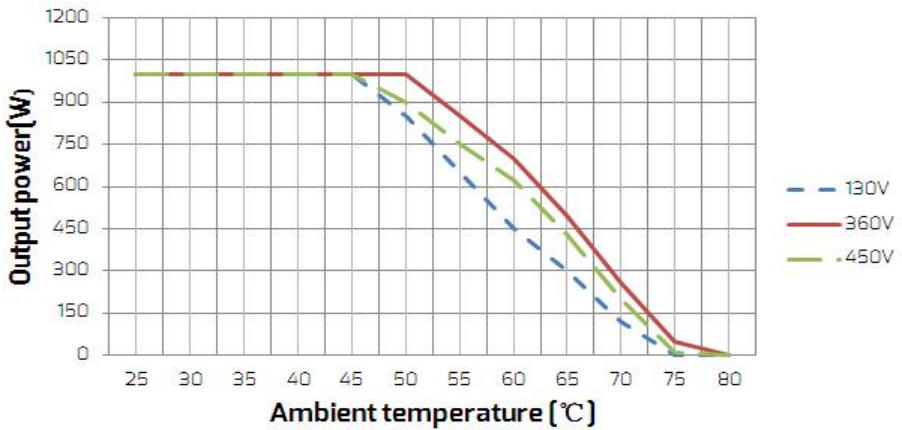

Power reduction with increased ambient temperature (IGPB 1000)

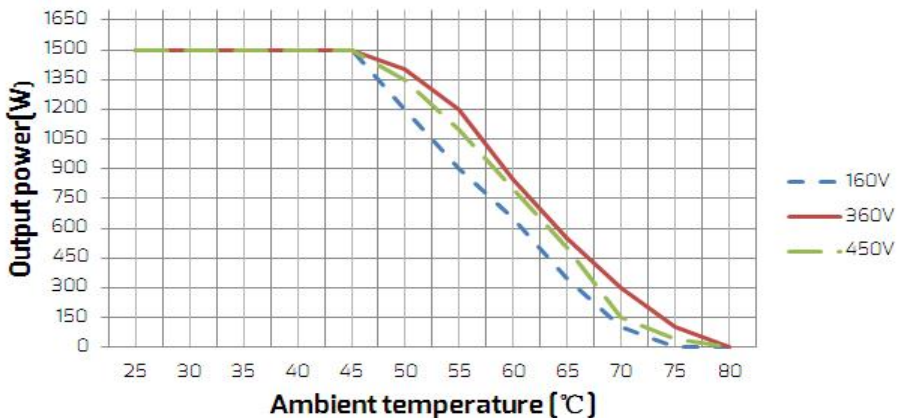

Power reduction with increased ambient temperature (IGPB 1500)

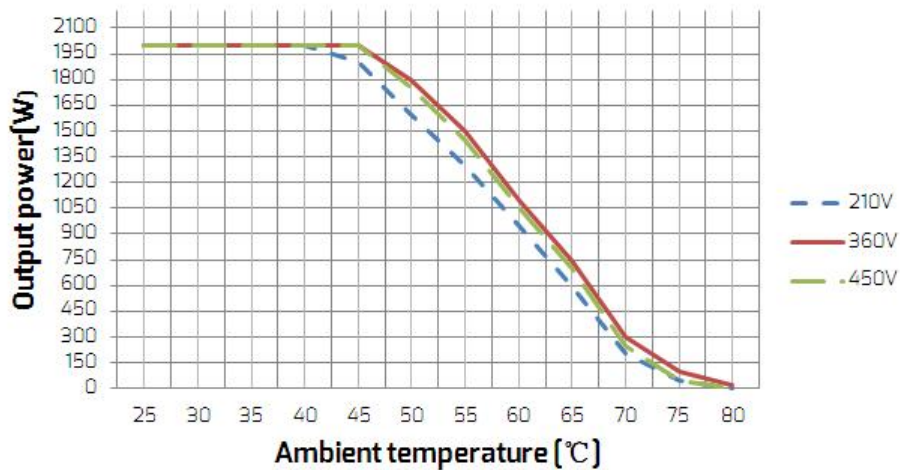

Power reduction with increased ambient temperature (IGPB 2000)

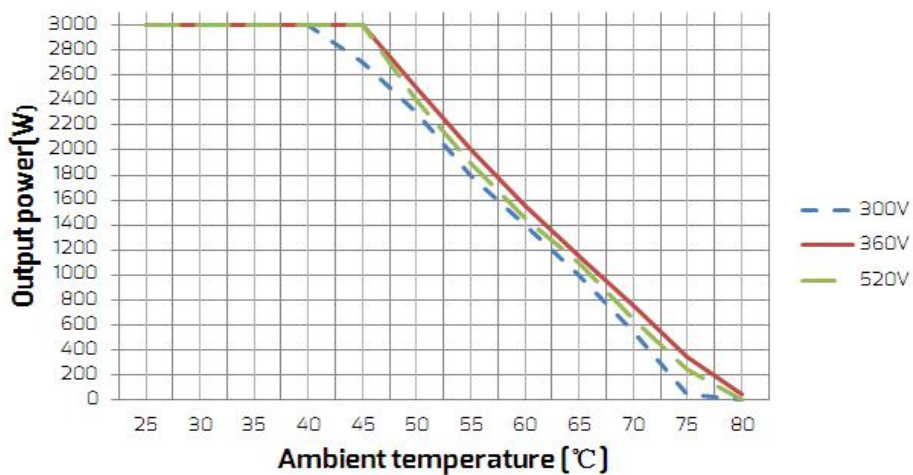

Power reduction with increased ambient temperature (IGPB 3000)

## 10.7 Tools and torque

Tools and torque required for installation and electrical connections.

Tools, model		Object	Torque
Torque screwdriver, T25		Screws for the cover	2.2Nm
		Screw for second protective grounding connection	
		Screws for tightening the inverter and wall bracket	
Flat-head screwdriver, blade with 1x5.5mm		Screw terminal block for AC cable	1.2Nm
Flat-head screwdriver, blade with 3.5mm		Sunclix DC connector	/
		Antenna	Hand-tight
Socket wrench	Open end of 30	Swivel nut of M25 cable gland	Hand-tight
	Open end of 24	Swivel nut of M20 cable gland	Hand-tight
	Open end of 15	Swivel nut of sunclix connector	2.0Nm
	Open end of 10	Hex bolts for wall bracket	/
Wire stripper		Peel cable jackets	/
Crimping tools		Crimp power cables	/
Hammer drill, drill bit of Ø10		Drill holes on the wall	/
Rubber mallet		Hammer wall plugs into holes	/
Cable cutter		Cut power cables	/
Multimeter		Check electrical connection	
Current clamp			
Marker		Mark the positions of drill holes	/
ESD glove		Wear ESD glove when opening the inverter	/
Safety goggle		Wear safety goggle during drilling holes.	/
Anti-dust respirator		Wear anti-dust respirator during drilling holes.	/

## 11 Troubleshooting

When the PV power plant does not operate normally, fault information will be shown up on the display of the inverter and the red LED will be lit at the same time.

We recommend the following actions for quick troubleshooting.

The corresponding causes are described in section 9.2 "Display messages".

Object	Error code	Corrective measures
Presumable Fault	6	<ul style="list-style-type: none"> <li>• Check the open-circuit voltages of the strings and make sure it is below the maximum DC input voltage of the inverter.</li> <li>• If the input voltage is within the permitted range and the fault still occurs, it might be that the internal circuit has broken. Contact the service.</li> </ul>
	33	<ul style="list-style-type: none"> <li>• Check the grid frequency and observe how often major fluctuations occur.</li> </ul> <p>If this fault is caused by frequent fluctuations, try to modify the operating parameters after informing the grid operator first.</p>
	34	<ul style="list-style-type: none"> <li>• Check the grid voltage and grid connection on inverter.</li> <li>• Check the grid voltage at the point of connection of inverter.</li> </ul> <p>If the grid voltage is outside the permissible range due to local grid conditions, try to modify the values of the monitored operational limits after informing the electric utility company first.</p> <p>If the grid voltage lies within the permitted range and this fault still occurs, please call service.</p>
	35	<ul style="list-style-type: none"> <li>• Check the fuse and the triggering of the circuit breaker in the distribution box.</li> <li>• Check the grid voltage, grid usability.</li> <li>• Check the AC cable, grid connection on the inverter.</li> </ul> <p>If this fault is still being shown, contact the service.</p>

Presumable Fault	36	<ul style="list-style-type: none"> <li>• Make sure the grounding connection of the inverter is reliable.</li> <li>• Make a visual inspection of all PV cables and modules. If this fault is still shown, contact the service.</li> </ul>
	37	<ul style="list-style-type: none"> <li>• Check the open-circuit voltages of the strings and make sure it is below the maximum DC input voltage of the inverter.</li> </ul> <p>If the input voltage lies within the permitted range and the fault still occurs, please call service.</p>
	38	<ul style="list-style-type: none"> <li>• Check the PV array's insulation to ground and make sure that the insulation resistance to ground is greater than 1 MΩ. Otherwise, make a visual inspection of all PV cables and modules.</li> <li>• Make sure the grounding connection of the inverter is reliable.</li> </ul> <p>If this fault occurs often, contact the service.</p>
	40	<ul style="list-style-type: none"> <li>• Check whether the airflow to the heat sink is obstructed.</li> <li>• Check whether the ambient temperature around the inverter is too high.</li> </ul>
	41, 42 43, 44 45	<ul style="list-style-type: none"> <li>• Disconnect the inverter from the grid and the PV arrays, reconnect them after 3 minutes.</li> </ul> <p>If this fault is still being shown, contact the service.</p>
Permanent Fault	1, 2, 3, 4, 5, 6, 8, 9	<ul style="list-style-type: none"> <li>• Disconnect the inverter from the utility grid and the PV arrays, reconnect them after display and LED turn off. If this fault is still being displayed, contact the service.</li> </ul>

Contact the Novergysolar service if you meet other problems not in the above table.

## 12 Maintenance

---

Normally, the inverter needs no maintenance or calibration. Regularly inspect the inverter and the cables for visible damage. Disconnect the inverter from all power sources before cleaning. Clean the housing, cover and display with a soft cloth. Ensure the heat sink at the rear of the inverter is not covered.

### 12.1 Cleaning the contacts of the DC switch

---

Clean the contacts of the DC switch annually. Perform cleaning by cycling the switch to | “ and ○ “ positions 5 times. The DC switch is located at the lower left of the housing.

### 12.2 Cleaning the heat sink

---

**CAUTION**

Risk of injury due to hot heat sink

- The heat sink may exceed 70°C during operation. Do not touch the heat sink during operation.
- Wait approx. 30 minutes before cleaning until the heat sink has cooled down.
- Ground yourself before touching any component.

Clean the heat sink with compressed air or a soft brush. Do not use aggressive chemicals, cleaning solvents or strong detergents.

For proper function and long service life, ensure free air circulation around the heat sink.

## 13 Recycling and disposal

---

Dispose of the packaging and replaced parts according to the rules applicable in the country where the device is installed.

Do not dispose the inverter with normal domestic waste.



### WEEE designation

Do not dispose of the product together with the household waste but in accordance with the disposal regulations for electronic waste applicable at the installation site.

## 14 Warranty

---

The factory warranty card is enclosed with the package, please keep well the factory warranty card. When the customer needs warranty service during the warranty period, the customer must provide a copy of the invoice, factory warranty card, and ensure the type label of the inverter is legible. If these conditions are not met, Novergysolar has the right to refuse to provide with the relevant warranty service.

## 15 Contact

---

If you have any technical problems concerning our products, please contact Novergy solar service. We require the following information in order to provide you with the necessary assistance:

- Inverter device type
- Inverter serial number
- Type and number of connected PV modules
- Error code
- Mounting location
- Warranty card

Novergy E. Sol. P . ltd.

Tel : +91-294-2415488 / 2415487 / 2450467

Email : [support@novergy.net](mailto:support@novergy.net) / [info@novergy.co.in](mailto:info@novergy.co.in)